

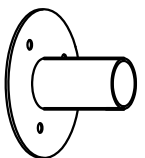









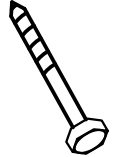
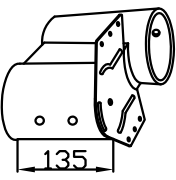
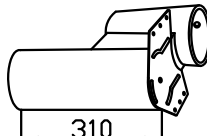
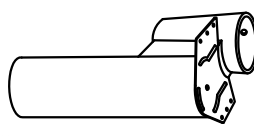
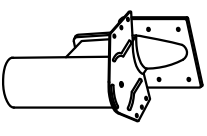
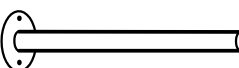





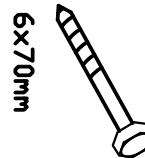



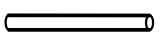

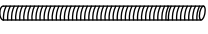
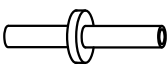

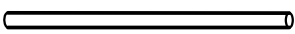

<p>A1</p>  <p>=1</p>	<p>A2</p>  <p>$\phi=12\text{mm}$</p> <p>=8</p>	<p>A3</p>  <p>8x80mm A8 =7</p>	<p>A4</p>  <p>135</p> <p>=1</p>	<p>A5</p>  <p>310</p> <p>=1</p>	<p>A6</p>  <p>=8</p>	<p>A7</p>  <p>=1</p>	<p>A8</p>  <p>=1</p>	<p>A9</p>  <p>=5</p>
<p>A10</p>  <p>M10x10mm</p> <p>=22</p> <p>HEX 5=1</p>	<p>A11</p>  <p>=9</p>	<p>A12</p>  <p>=1</p>	<p>A13</p>  <p>$\phi=10\text{mm}$</p> <p>=2</p>	<p>A14</p>  <p>6x70mm</p> <p>=2</p>	<p>A15</p>  <p>A6</p> <p>=2</p>		<p>B1</p>  <p>M8x80mm</p> <p>=1</p>	<p>B2</p>  <p>=1</p>
<p>B3</p>  <p>=3</p>	<p>B4</p>  <p>192x18 mm</p> <p>=1</p>	<p>B5</p>  <p>=2</p>	<p>B6</p>  <p>M8x90mm</p> <p>=1</p>	<p>B7</p>  <p>=1</p>	<p>B8</p>  <p>=14</p>	<p>B9</p>  <p>=1</p>	<p>B10</p>  <p>=15</p>	<p>B11</p>  <p>=14</p>
<p>B12</p>  <p>4,2x12mm</p> <p>=28</p>	<p>C1</p>  <p>=22</p>	<p>C2</p>  <p>4X25mm</p> <p>=44</p>	<p>C3</p>  <p>4X30mm</p> <p>=22</p>	<p>C4</p>  <p>=22</p>	<p>C5</p>  <p>M6x6mm</p> <p>HEX 3=1</p> <p>=22</p>	<p>D1</p>  <p>=11</p>	<p>D2</p>  <p>5x25mm</p> <p>=66</p>	

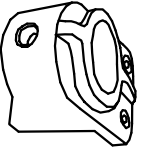

1

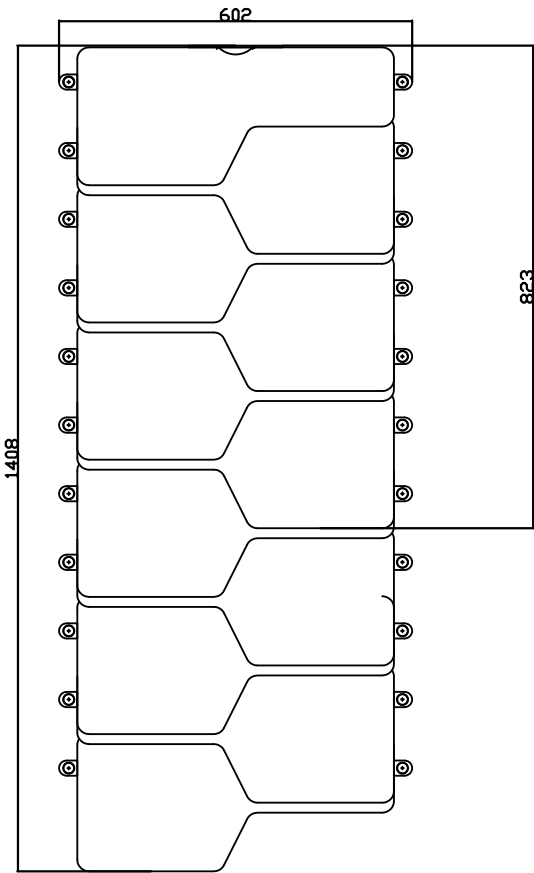
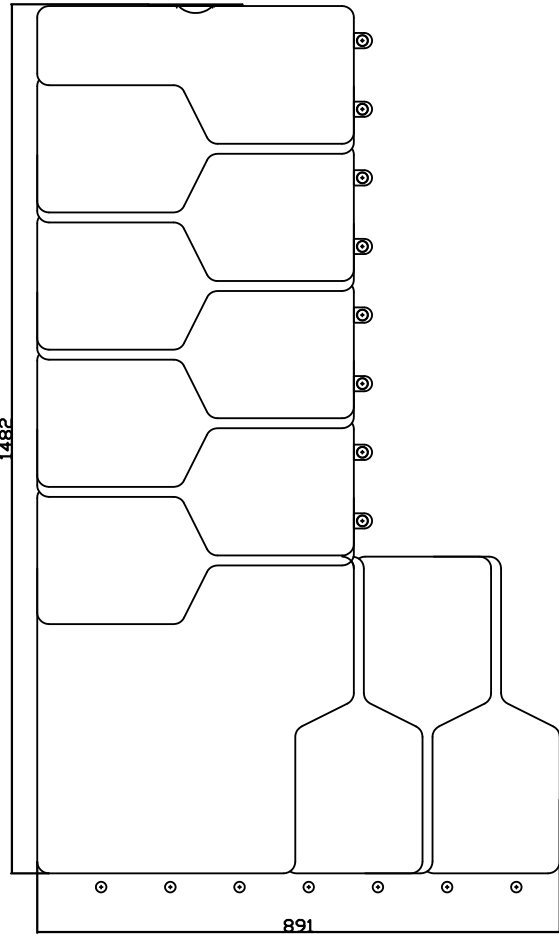

2

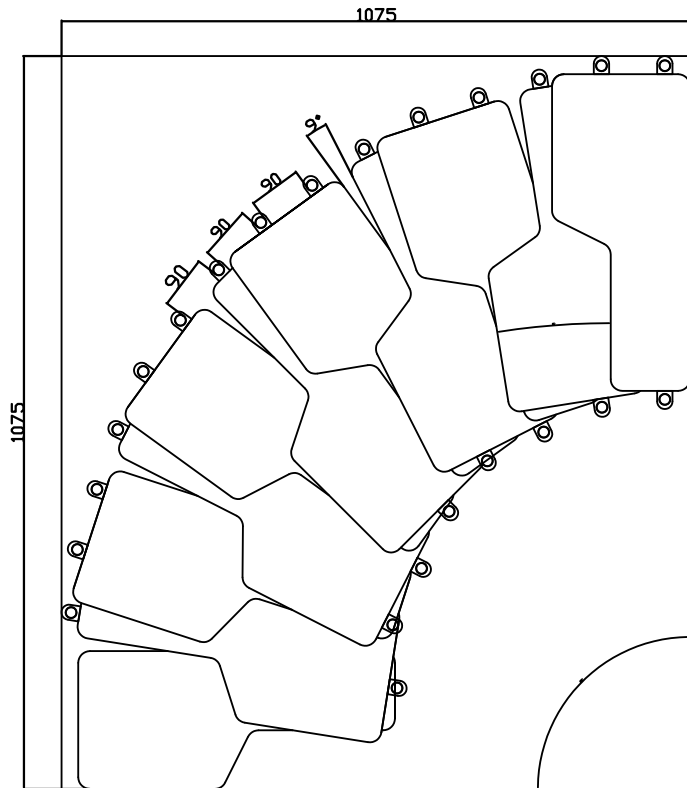

3

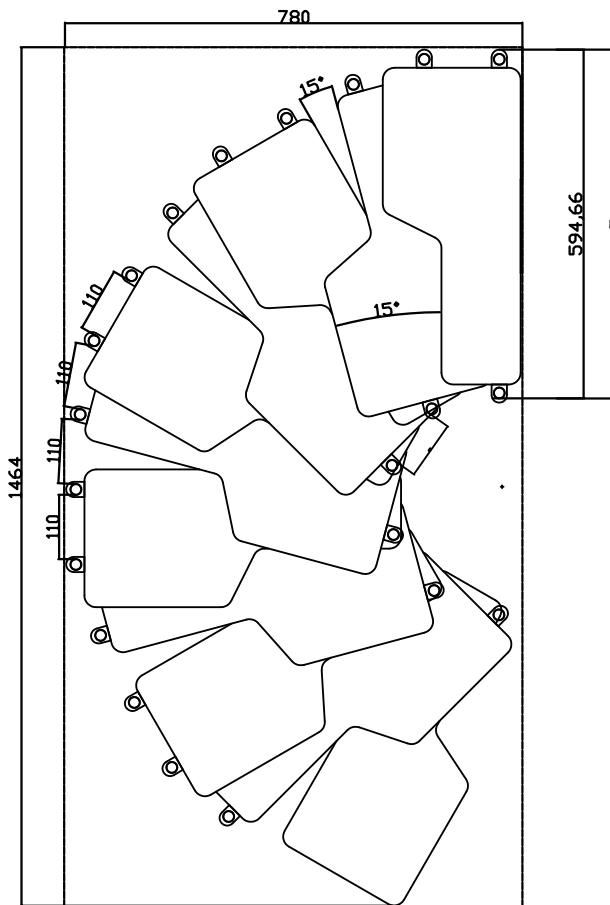

4

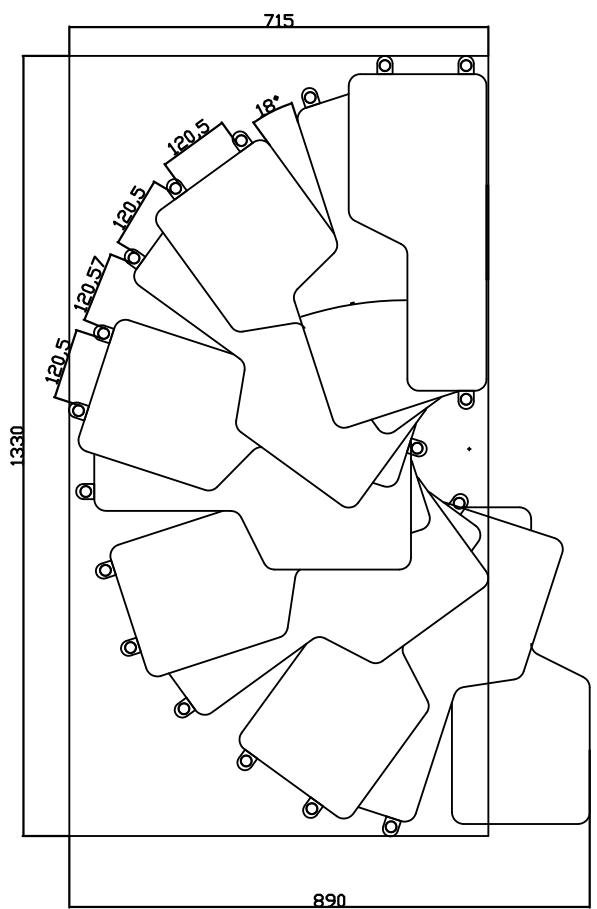

5

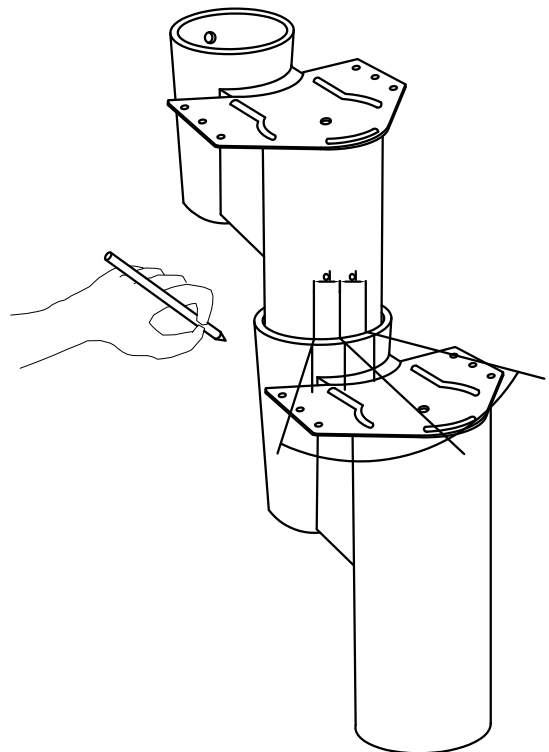

	1,2	3	4	5
a	0°	9°	15°	18°
d	0mm	6 mm	10 mm	12 mm