

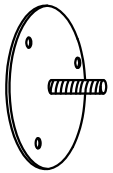









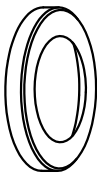
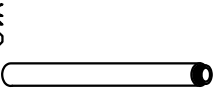



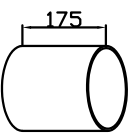
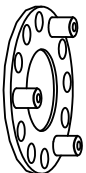
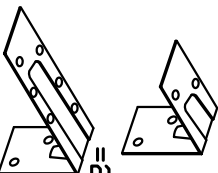

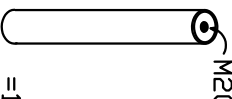
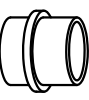
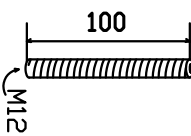

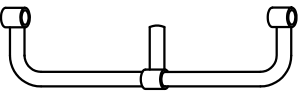

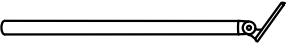
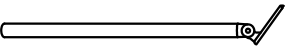
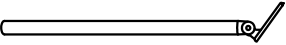



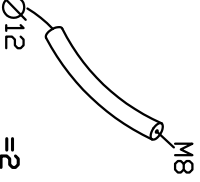
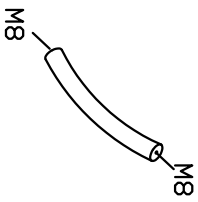
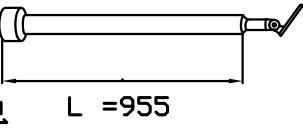
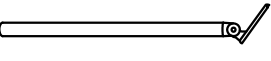
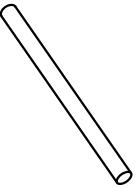







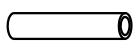
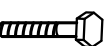
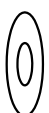

A1		=1
A2	 12 mm Ø12	=3
A3	 Ø8x80	=3
A4		=1
A5	 M12	=1
A6	 M20 M12	=1
A7		=1
A8	 A20	=1
A9	 M20	=2
A10	 175 D120=Ø100 D140=Ø100 D160=Ø114	=13
A11		=78
A12	 =2	=2
A13	 5x25	=12
A14	 Ø6x80	=8
A16	 M20	=1
A17		=8
A18	 M12 100	=1
A19		=2
B1		=1
B2	 4x13mm	=7
B3	 1120 mm	=13
B4	 937 mm	=12
B5	 1012 mm	=12
B6	 4X16	=92
B7	 M8x40mm	=11
B8		=11
B9	 Ø12 M8	=2
B10	 M8 =10	=10
B11	 955	=1
B12	 955 mm D120 D140 D160 =5 =6 =7	=5 =6 =7
B13		=1
B14		=4
B15		=1
B16		=2
B17	 5x50	=2
B18	 10 mm Ø10	=10

C1	 12 mm Ø12 =2	C2	 M8x80 =2	C3	 =34	C4	 =36	C5	 200 mm =1	C6	 M8x60mm =32	C7	 8 mm A8x24 =32	C8	 =25	C9	 =25
C10	 =25	C11	 M6x6 HEX 3=1 =25	C12	 =2	C13	 M8x90mm =1	C14	 =1	C15	 =12	D1	 =12	D2	 =1		

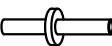

2x A11 → h=215mm

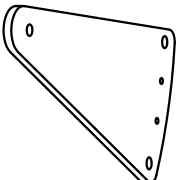
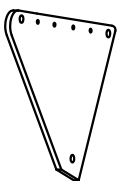
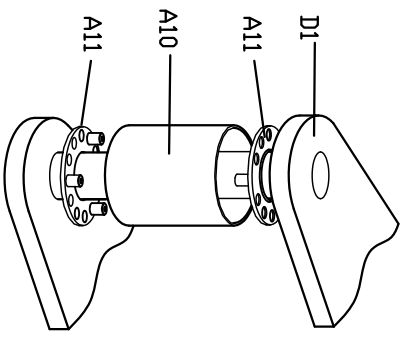
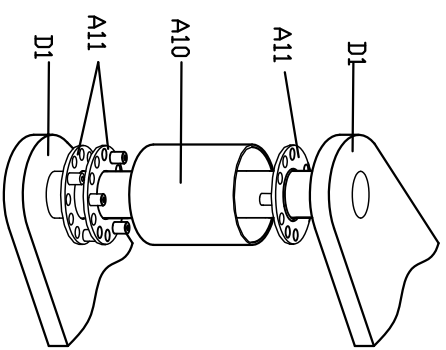

3x A11 → h=220mm

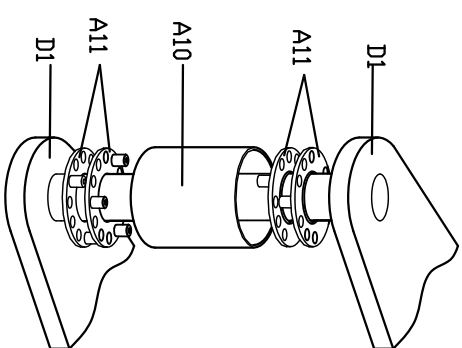

4x A11 → h=225mm

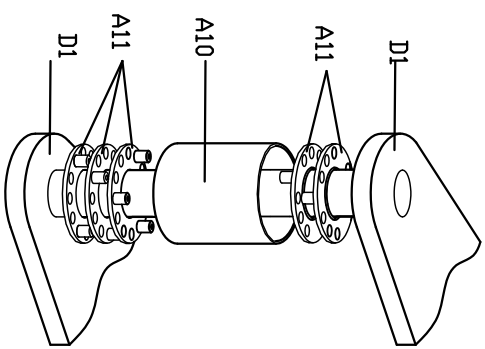

5x A11 → h=230mm

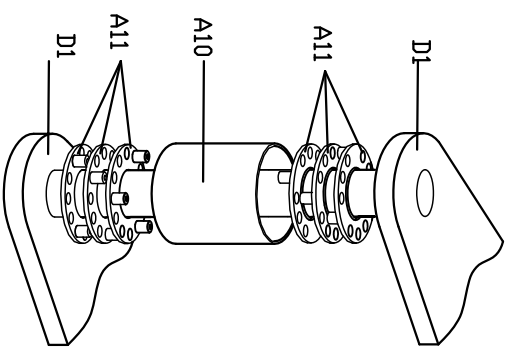

6x A11 → h=235mm

HELICO D 120/140/160

