

# HELICO NEW

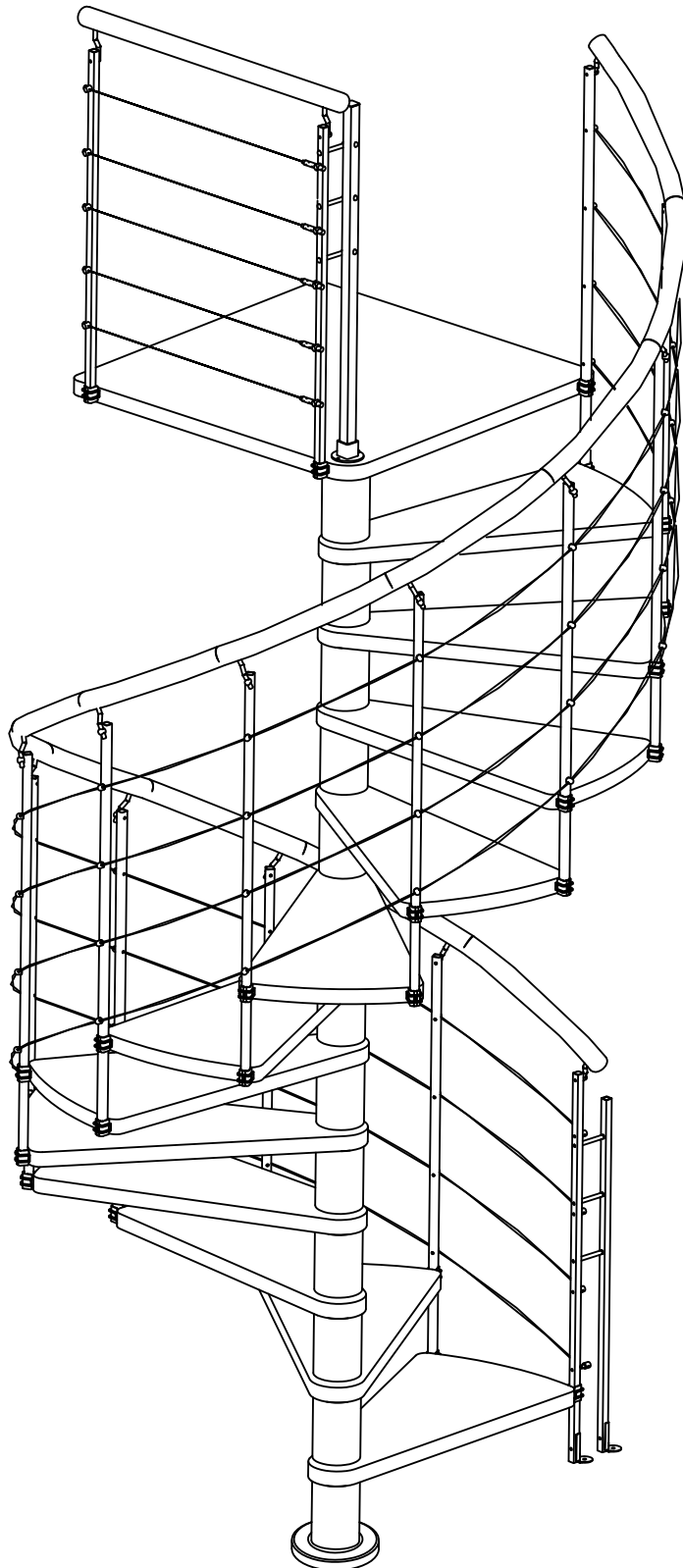

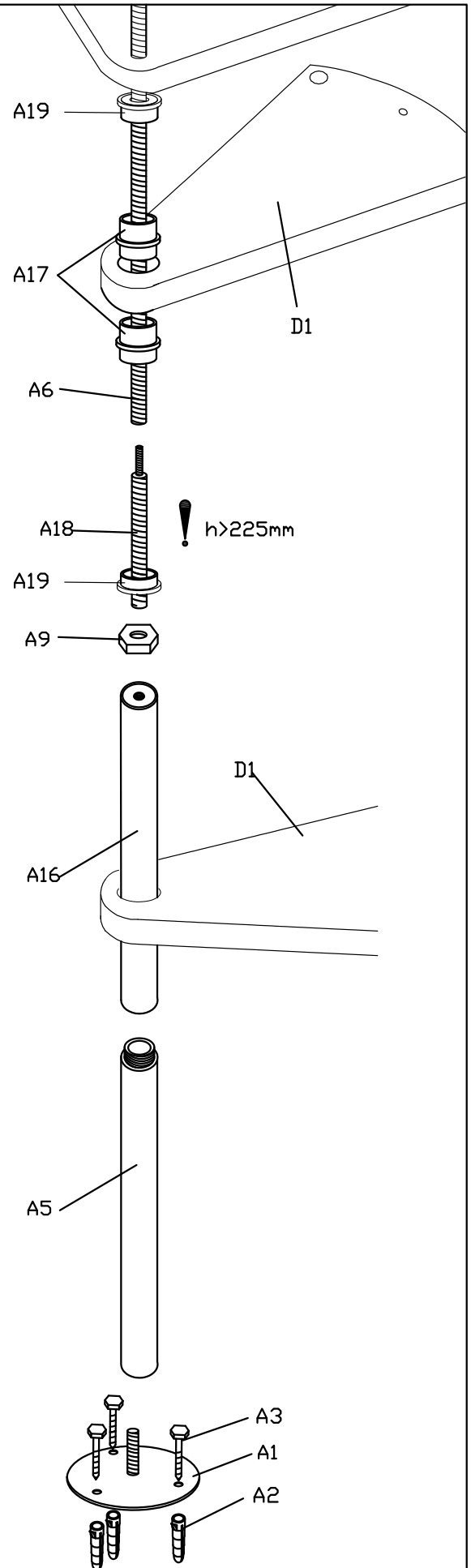

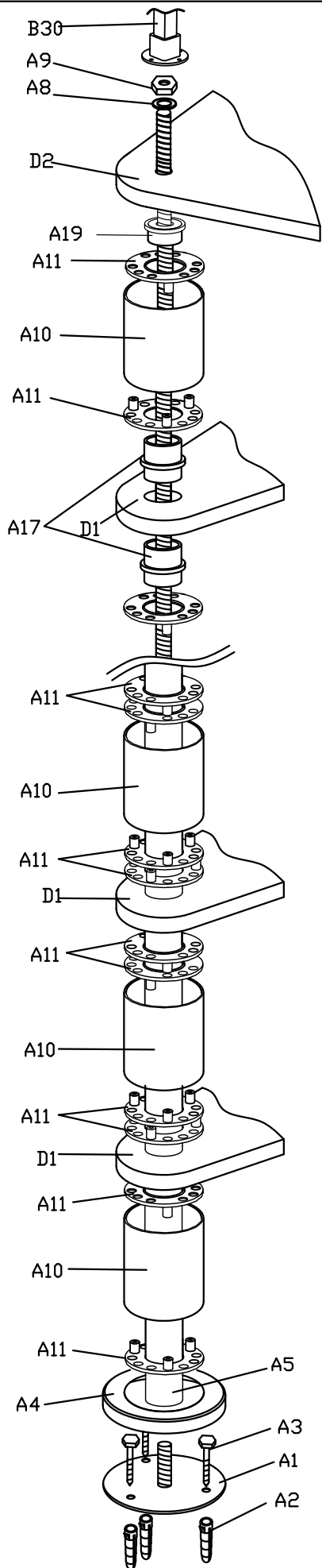

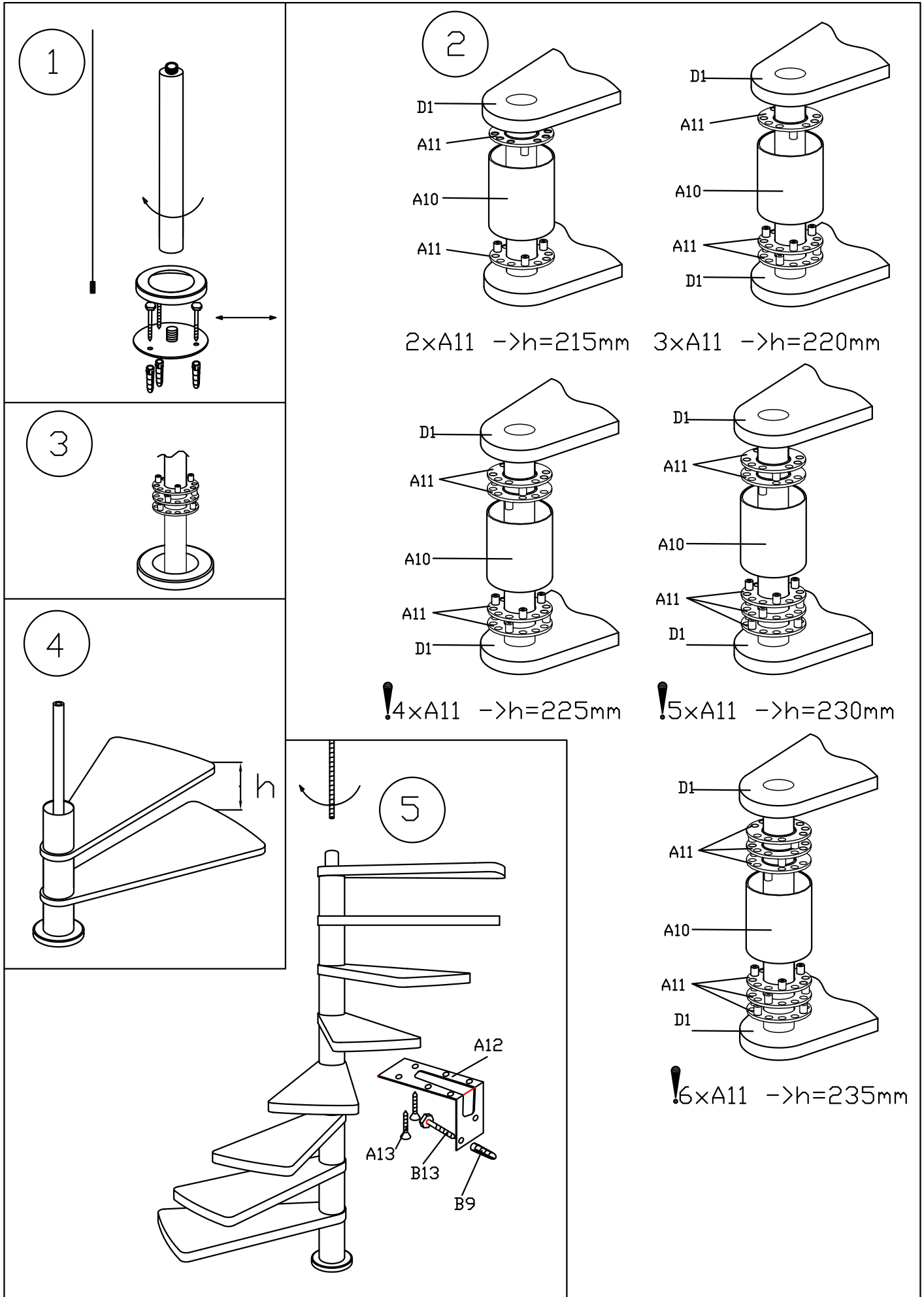
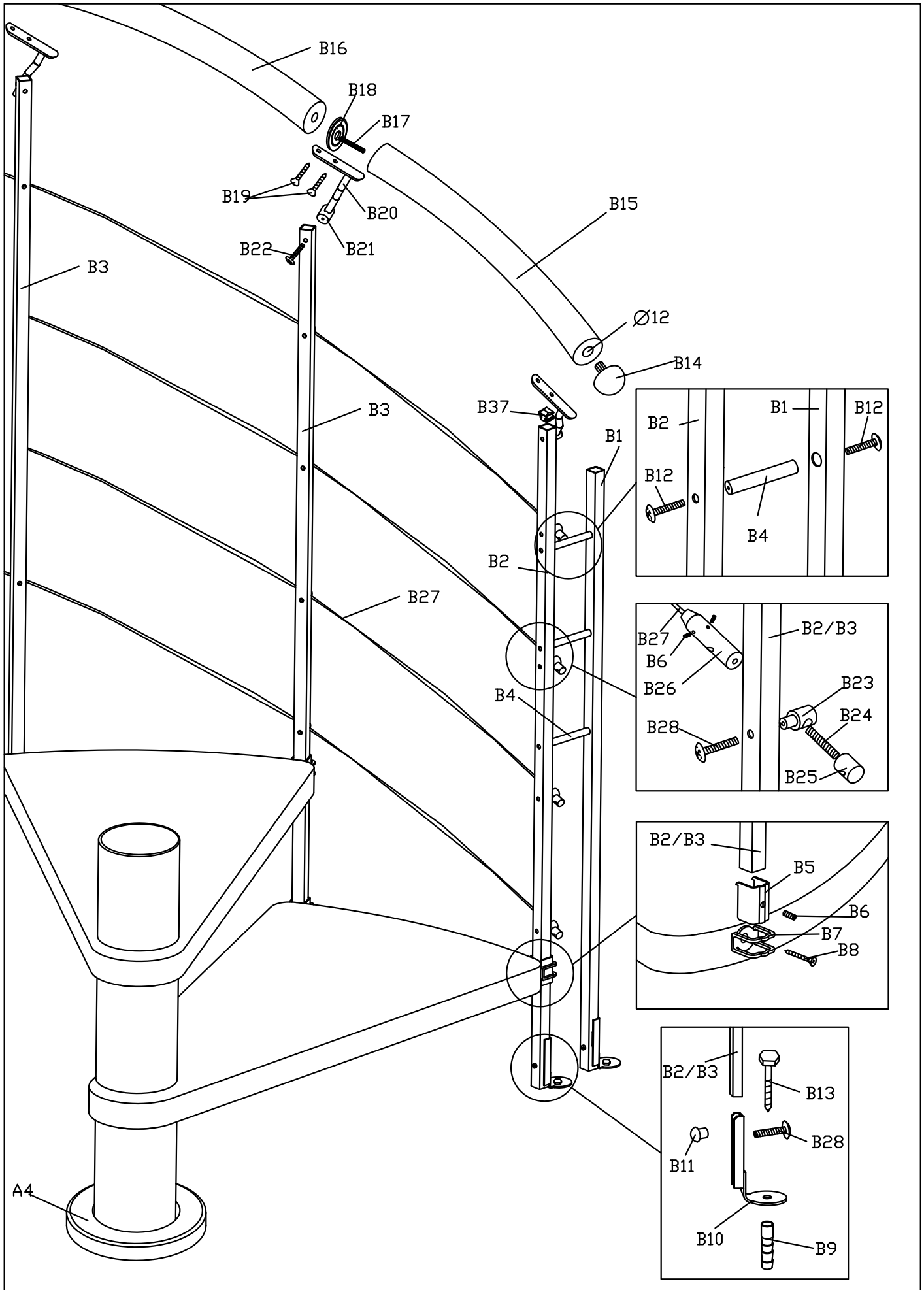

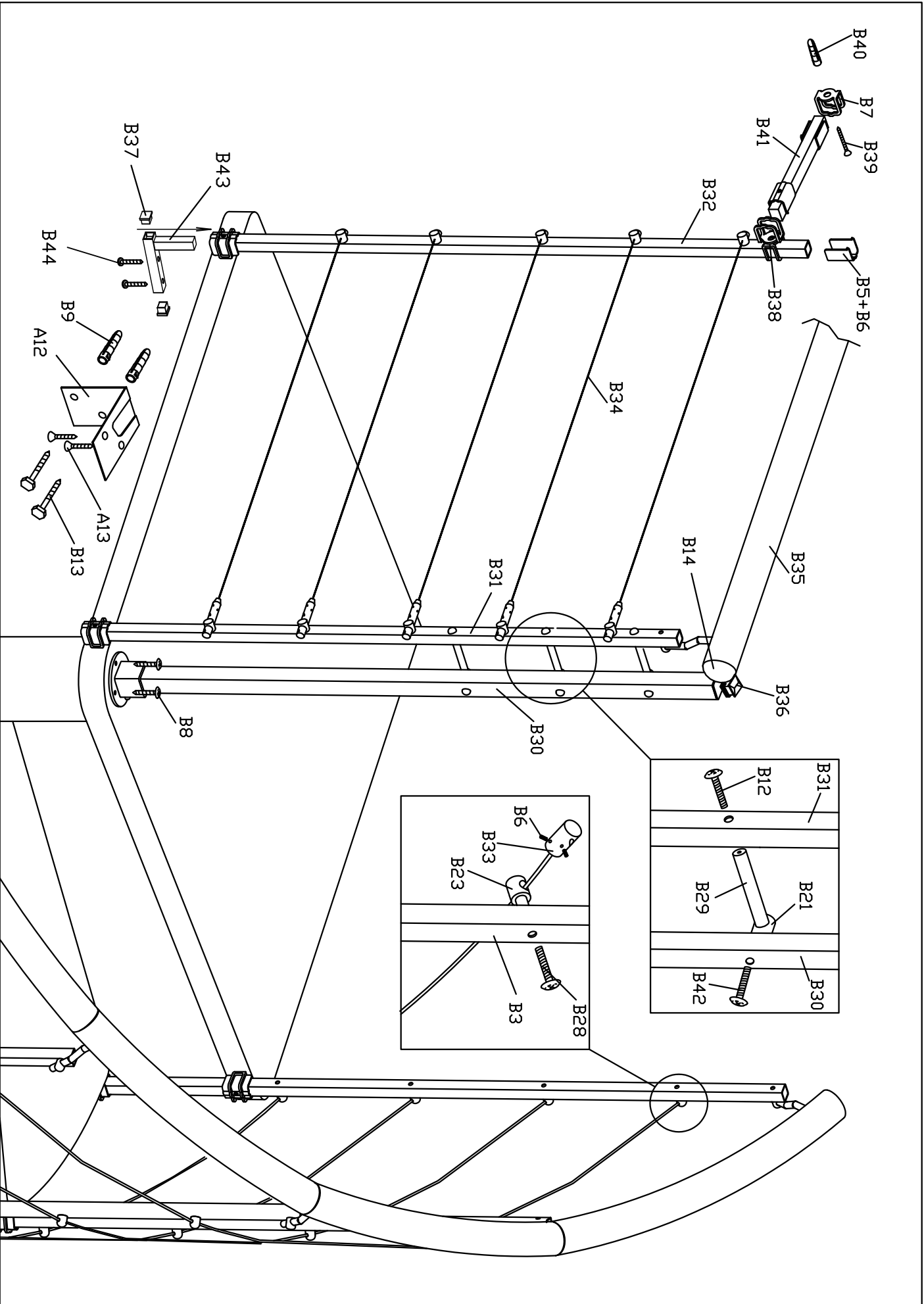

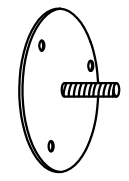

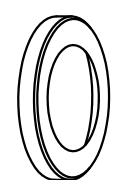
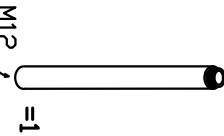
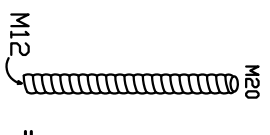

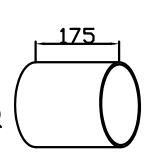
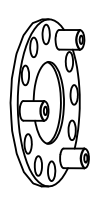
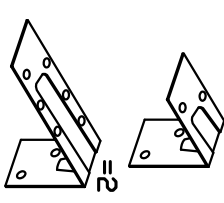

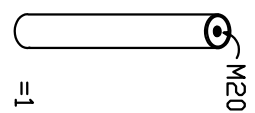
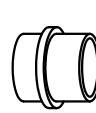
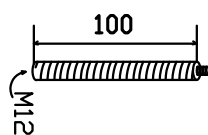

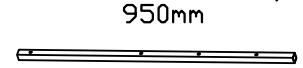
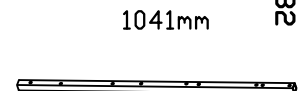
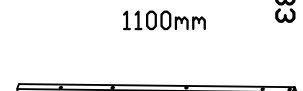
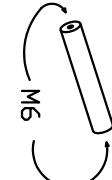





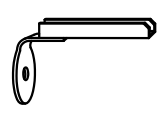



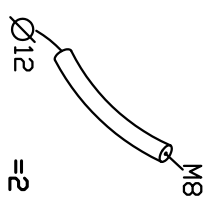
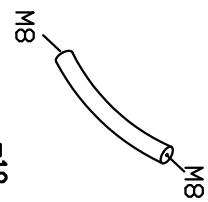











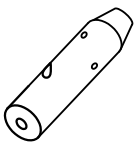
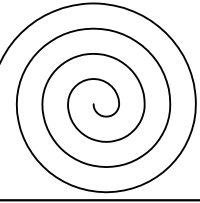

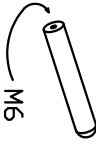

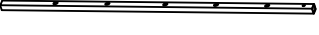
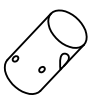

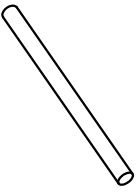





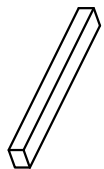

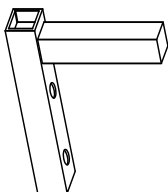

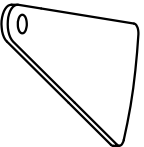
A1		=1
A2	 12 mm Ø12	=3
A3	 Ø8x80	=3
A4		=1
A5	 M12	=1
A6	 M20 M12	=1
A8	 A20	=1
A9	 M20	=2
A10	 175 D120=Ø100 D140=Ø100 D160=Ø114	=13
A11		=78
A12	 =2	=2
A13	 5x25	=12
A16	 M20	=1
A17		=7
A18	 M12 100 M12	=1
A19		=1
B1	 950mm	=1
B2	 1041mm	=1
B3	 1100mm	=12
B4	 M6	=3
B5		=30
B6	 M6x6 =66 HEX 3=1	
B7		=28
B8	 5x35	=31
B9	 10 mm Ø10	=10
B10		=2
B11	 M6x10	=2
B12	 M6x10	=9
B13	 Ø6x80	=10
B14		=4
B15	 Ø12 M8	=2
B16	 M8 M8	=10

B17	 M8x40mm	=11	B18		=11	B19	 4X16	=30	B20		=15	B21		=18	B22	 M6X12	=15	B23		=62	B24	 M5x40mm	=9	B25		=9
B26		=9	B27	 L=550cm =4	=4	B28	 M6X16	=64	B29	 M6	=3	B30	 940mm	=1	B31	 980mm	=1	B32	 980mm	=1	B33		=9	B34	 L=85cm	=5
B35		=1	B36	 30X30	=1	B37	 20X20	=32	B38		=1	B39	 5X60	=1	B40	 Ø8	=1	B41	 200mm	=1	B42	 M6X25	=3	B43		=1
B44	 5X45	=2	D1		=12	D2		=1																		